

Series PS3000

Section Details

ACM Wet Joint System

Scale : NTS

5 April 2018

A100

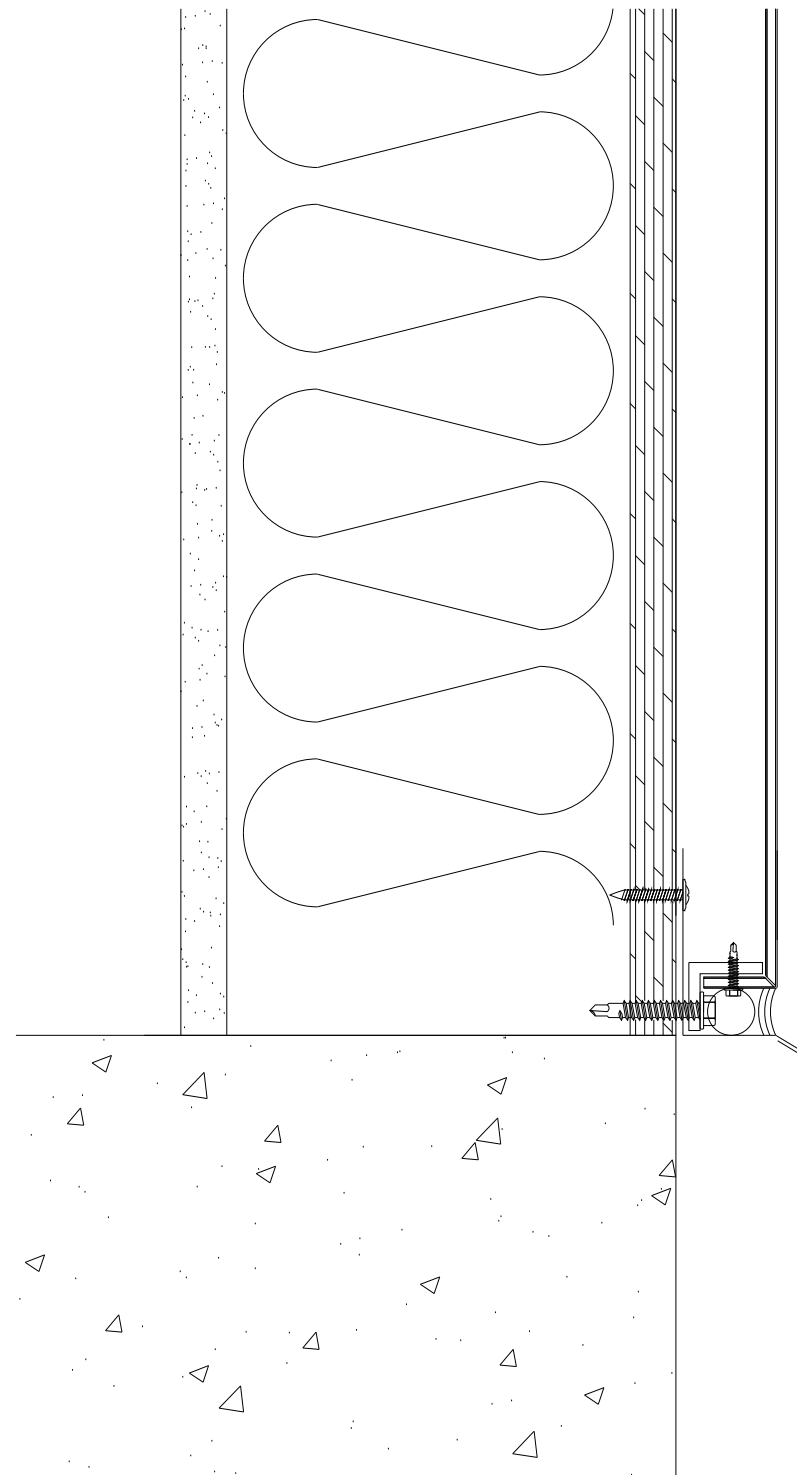

Premier Panel Systems

premierpanelsystems.com

Ph: (517) 579-3202

info@premierpanelsystems.com

Series PS3000

Sill Detail

ACM Wet Joint System

Scale : NTS

5 April 2018

A101

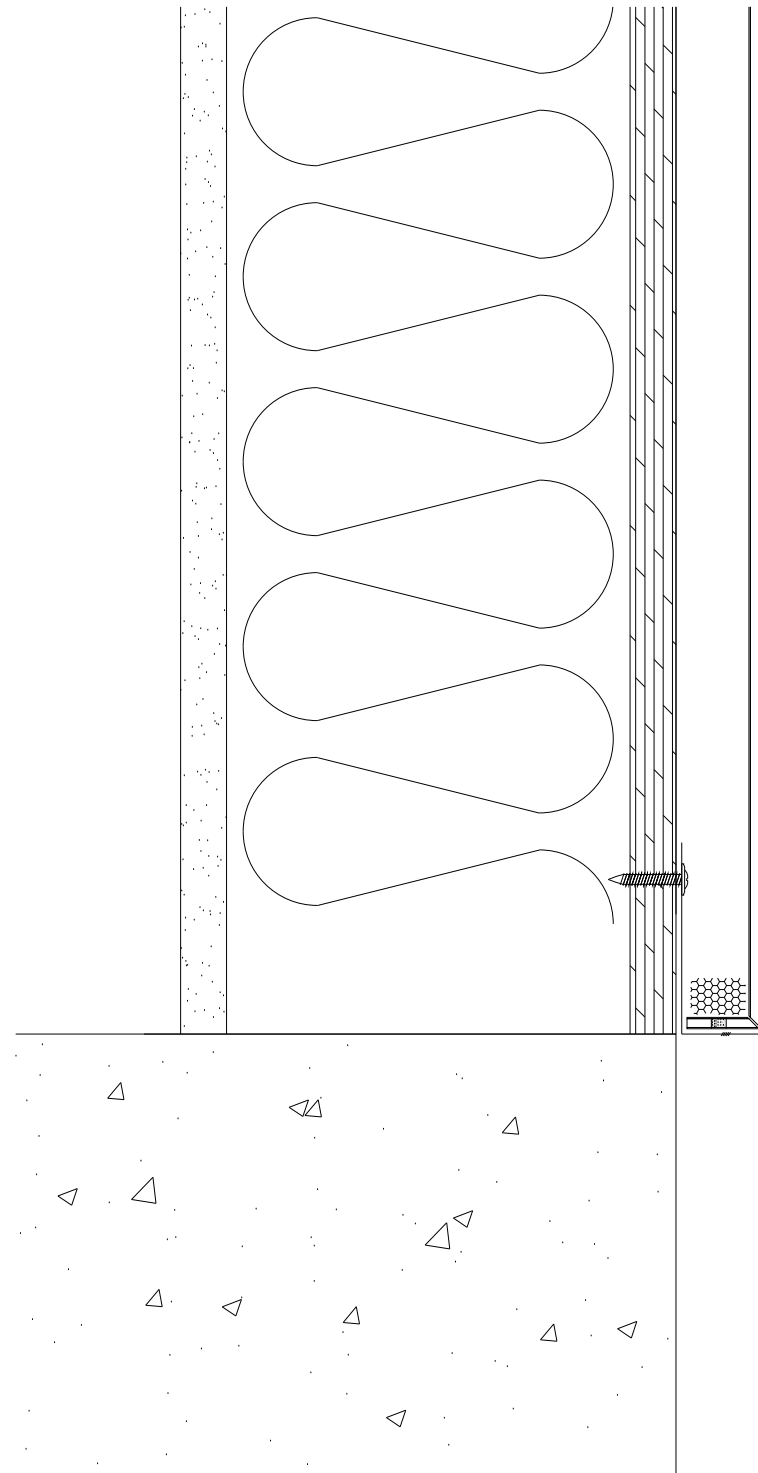

Premier Panel Systems

premierpanelsystems.com

Ph: (517) 579-3202

info@premierpanelsystems.com

Series PS3000

Optional Sill Detail

ACM Wet Joint System

Scale : NTS

5 April 2018

A101.1

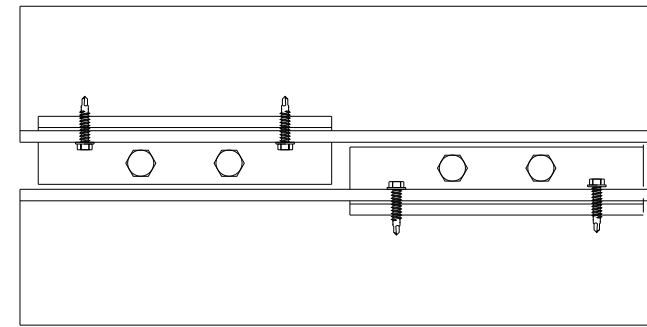
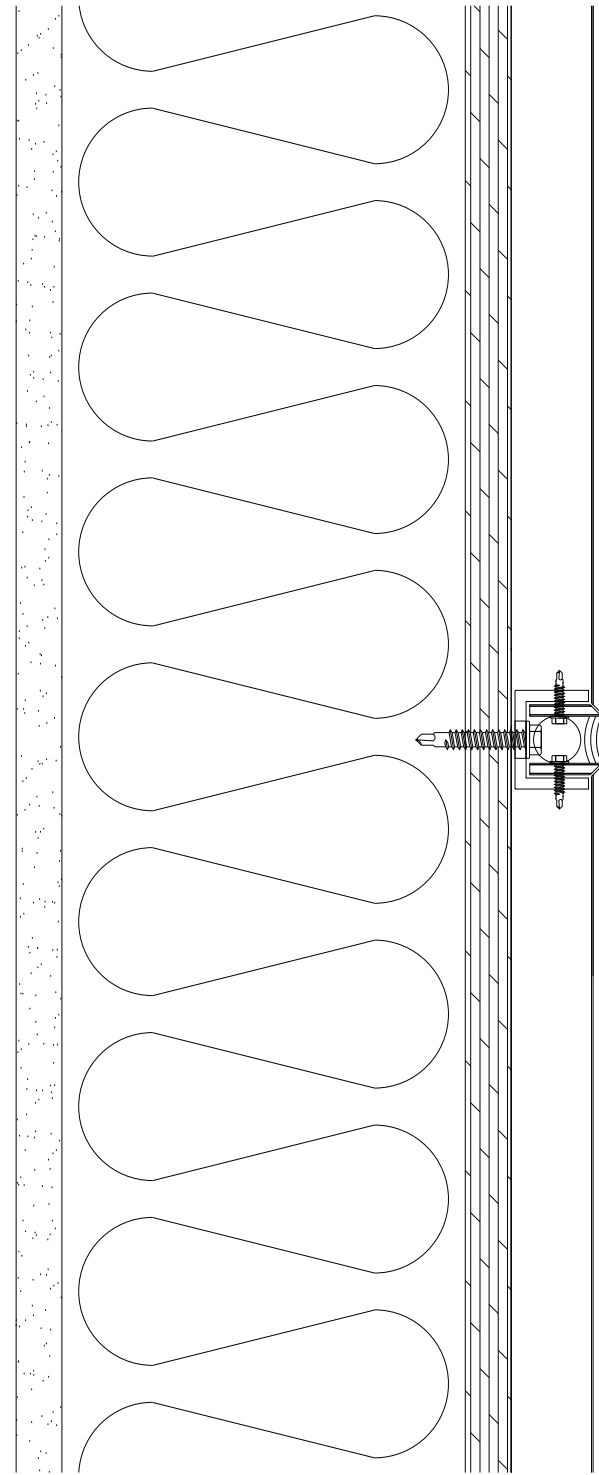

Premier Panel Systems

premierpanelsystems.com

Ph: (517) 579-3202

info@premierpanelsystems.com

Series PS3000

Horizontal Panel Seam

ACM Wet Joint System

Scale : NTS

5 April 2018

A102

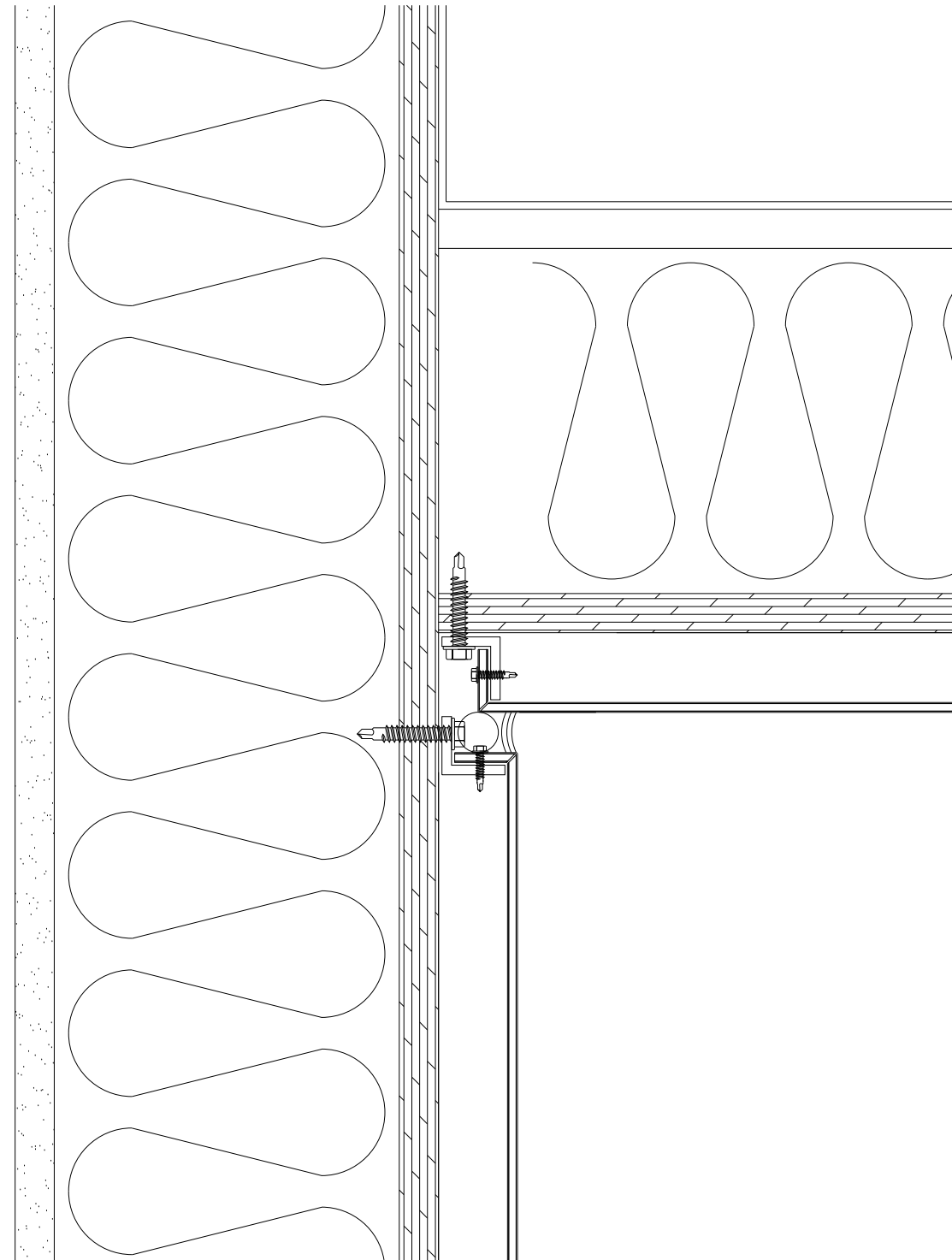

Premier Panel Systems

premierpanelsystems.com

Ph: (517) 579-3202

info@premierpanelsystems.com

Series PS3000

Soffit to Wall Detail

ACM Wet Joint System

Scale : NTS

5 April 2018

A103

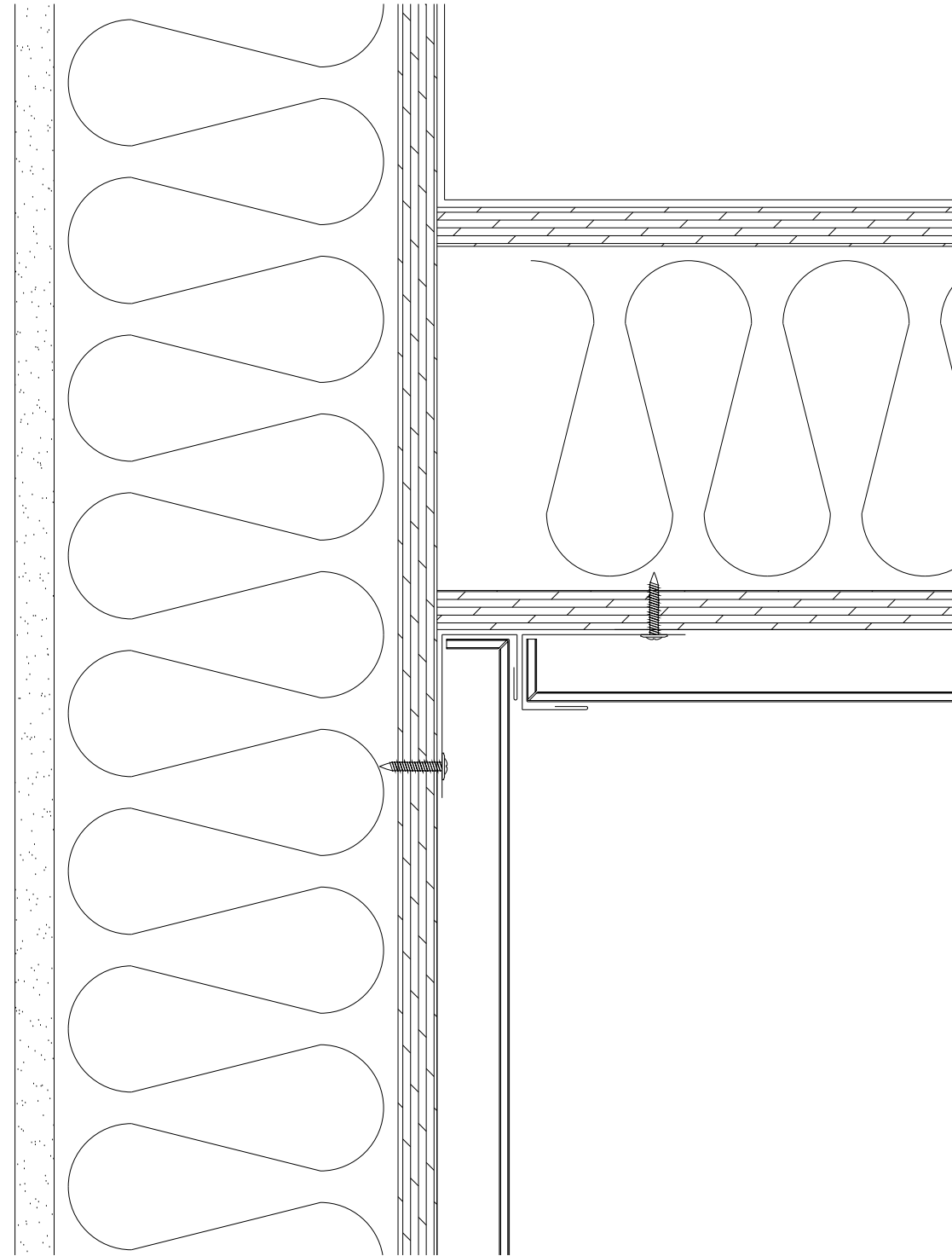

Premier Panel Systems

premierpanelsystems.com

Ph: (517) 579-3202

info@premierpanelsystems.com

Series PS3000

Optional Soffit to Wall Detail

ACM Wet Joint System

Scale : NTS

5 April 2018

A103.1

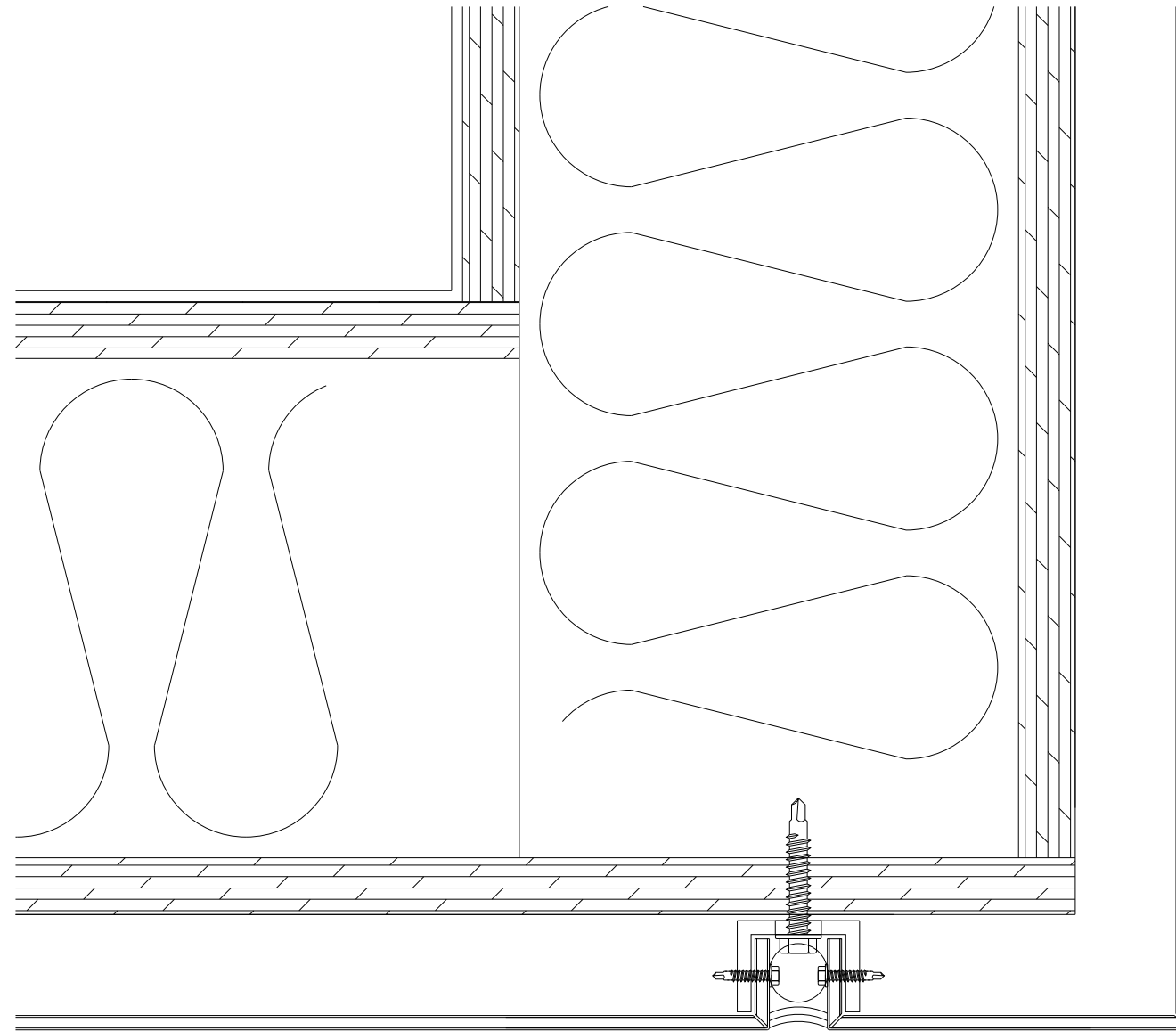

Premier Panel Systems

premierpanelsystems.com

Ph: (517) 579-3202

info@premierpanelsystems.com

Series PS3000

Fascia to Soffit Detail

ACM Wet Joint System

Scale : NTS

5 April 2018

A104

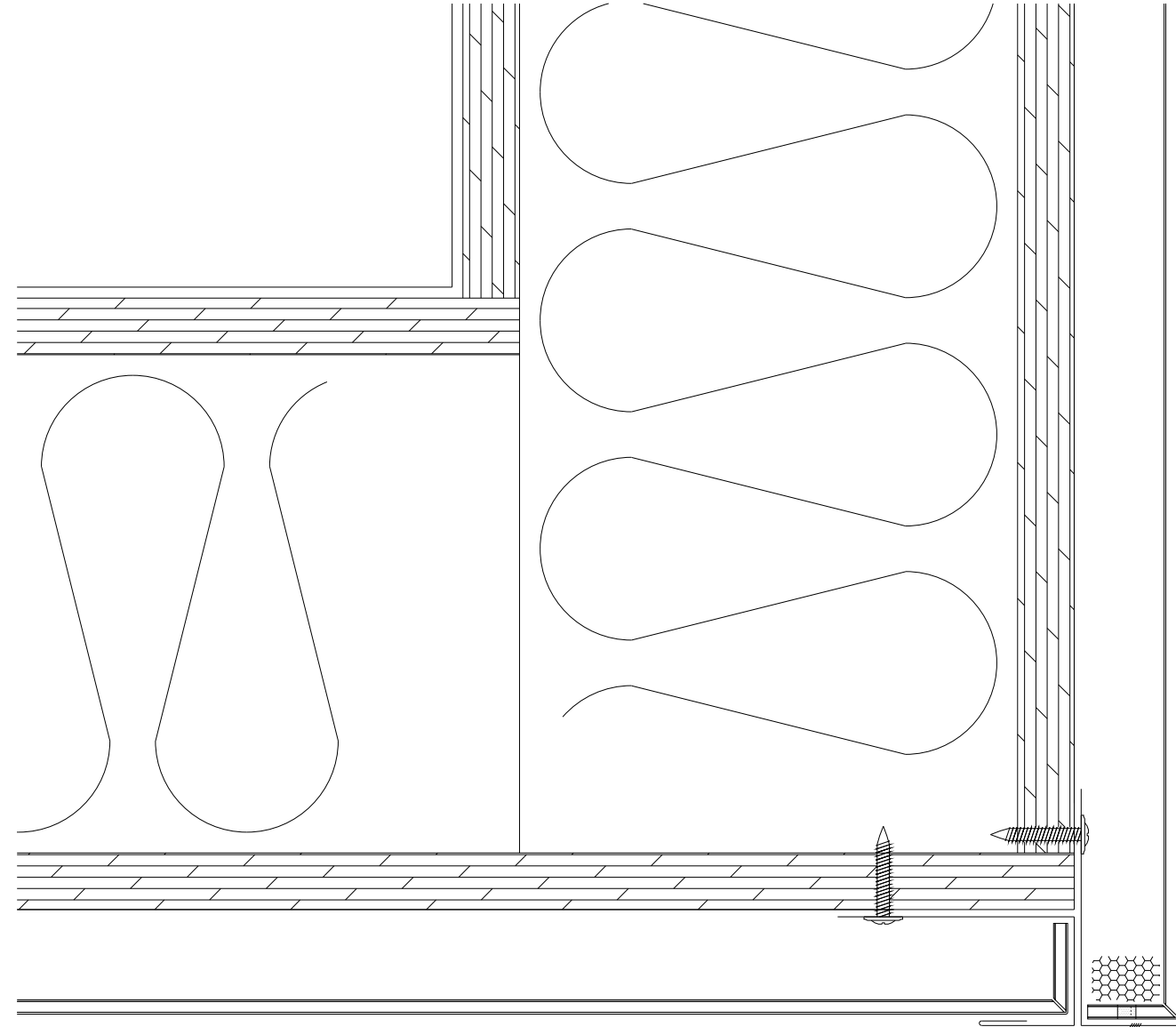

Premier Panel Systems

premierpanelsystems.com

Ph: (517) 579-3202

info@premierpanelsystems.com

Series PS3000

Optional Fascia to Soffit Detail

ACM Wet Joint System

Scale : NTS

5 April 2018

A104.1

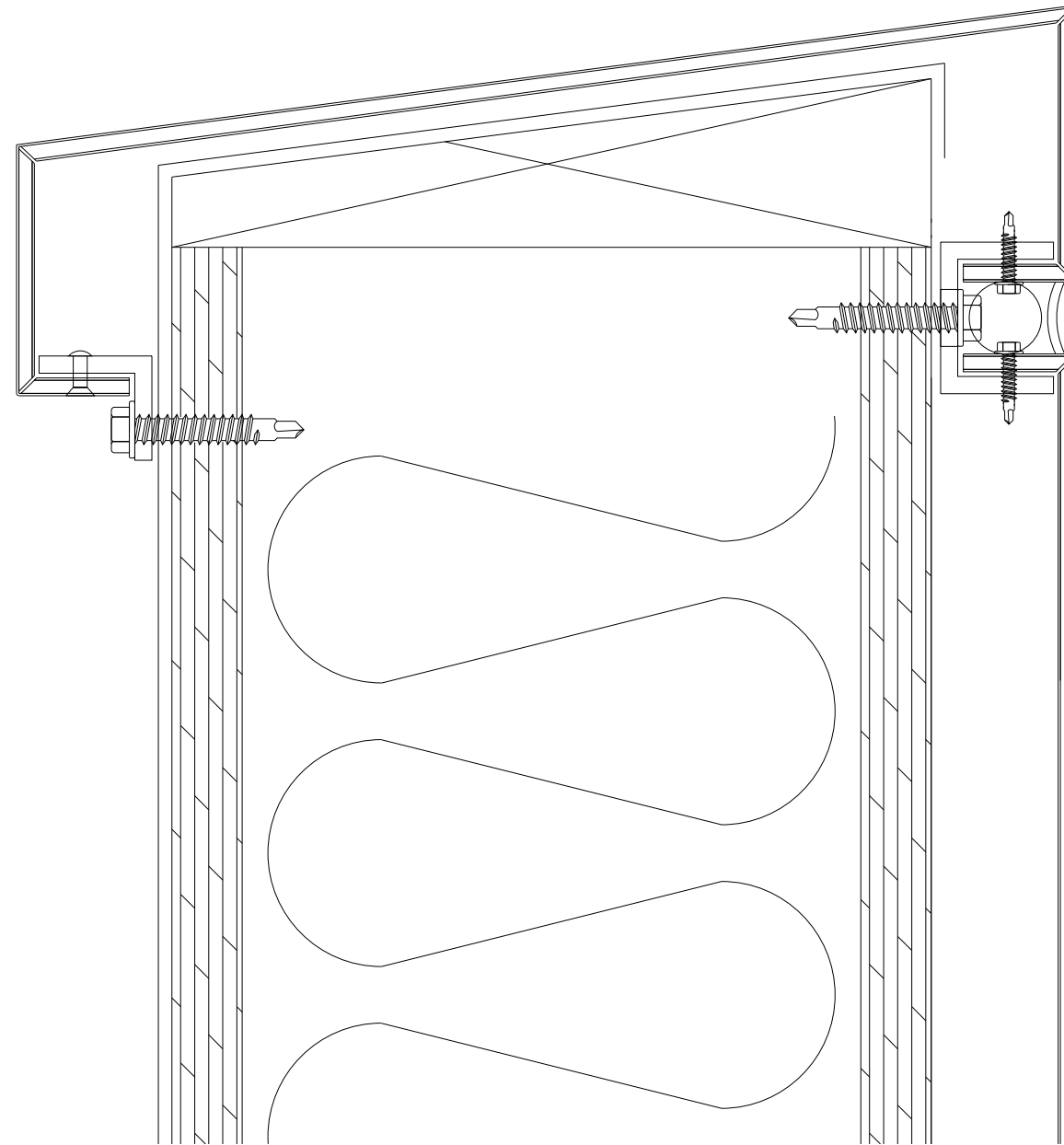

Premier Panel Systems

premierpanelsystems.com

Ph: (517) 579-3202

info@premierpanelsystems.com

Series PS3000

Coping Detail

ACM Wet Joint System

Scale : NTS

5 April 2018

A105

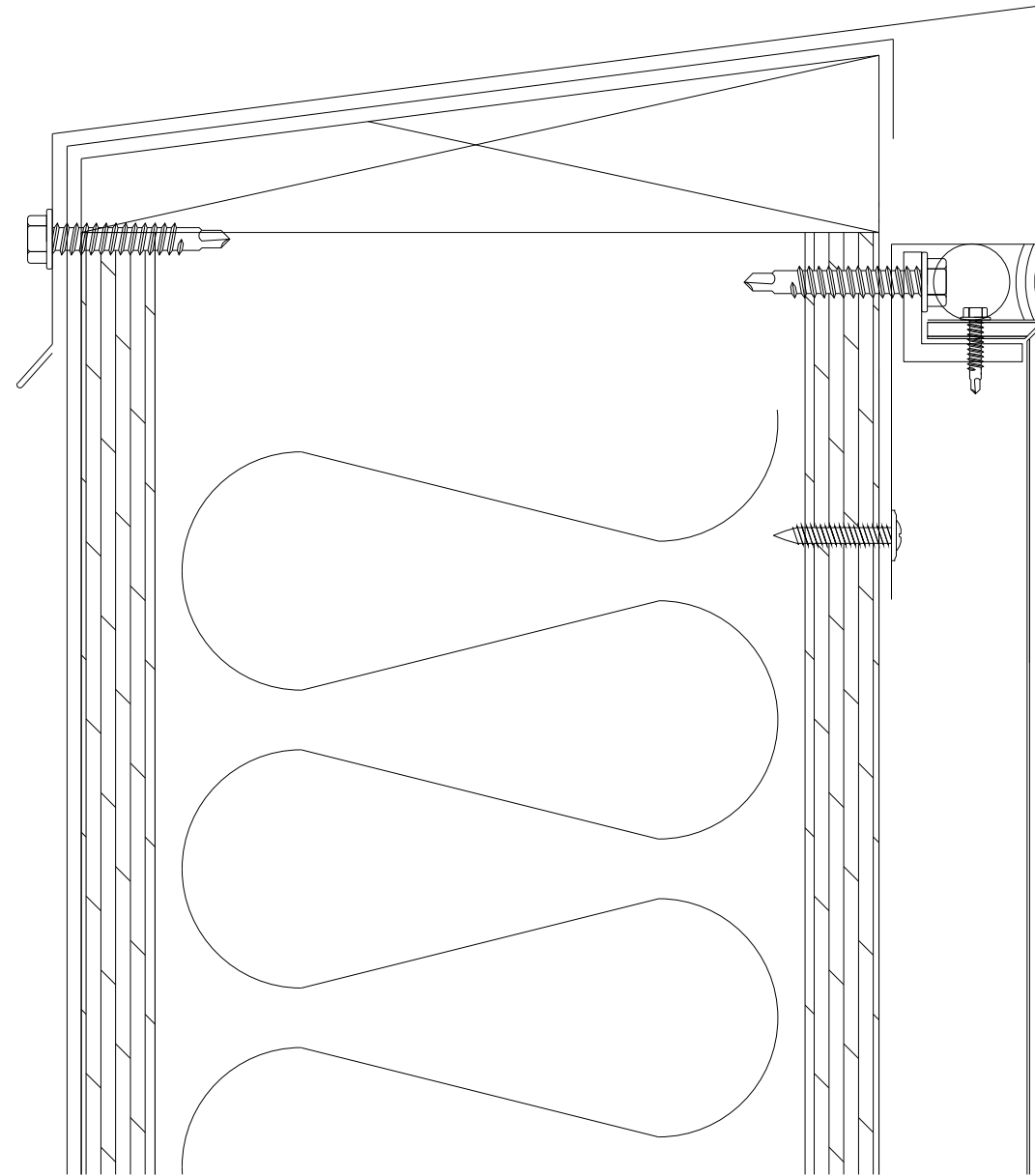

Premier Panel Systems

premierpanelsystems.com

Ph: (517) 579-3202

info@premierpanelsystems.com

Series PS3000

Optional Coping Detail

ACM Wet Joint System

Scale : NTS

5 April 2018

A105.1

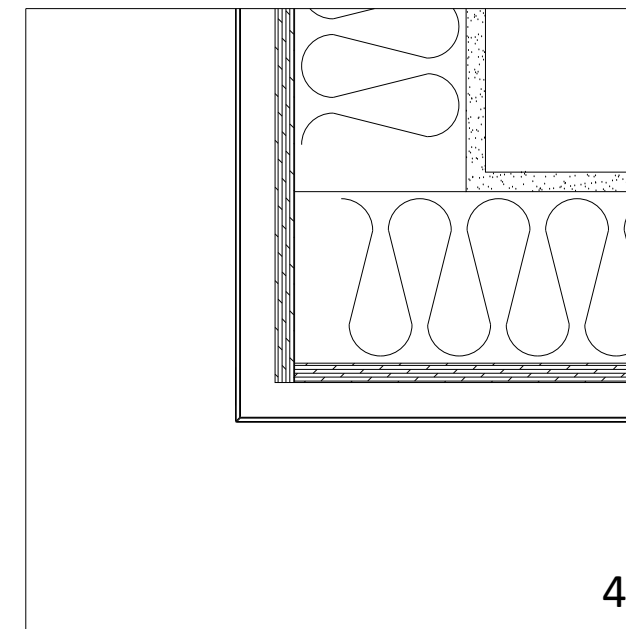
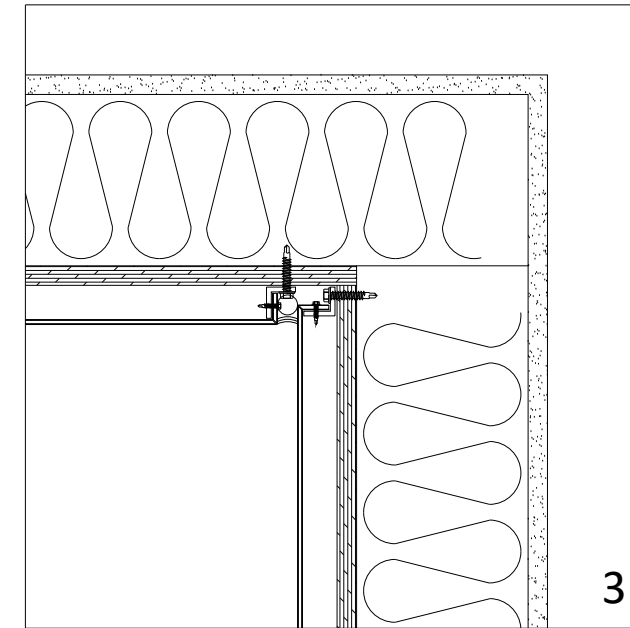
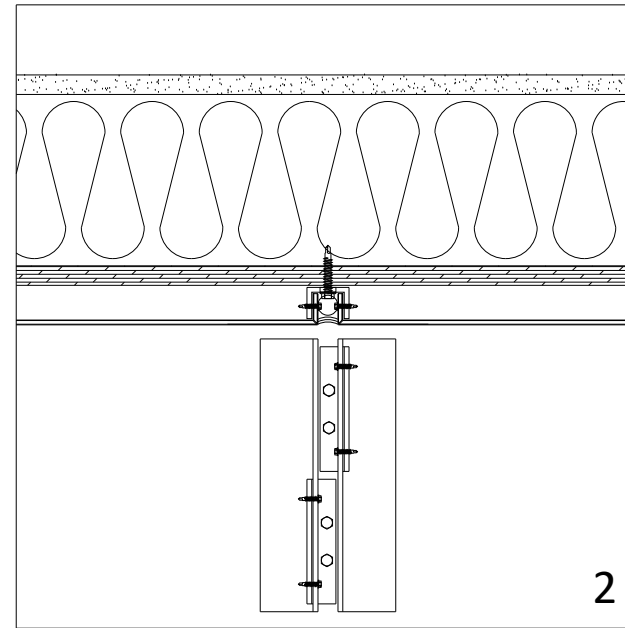
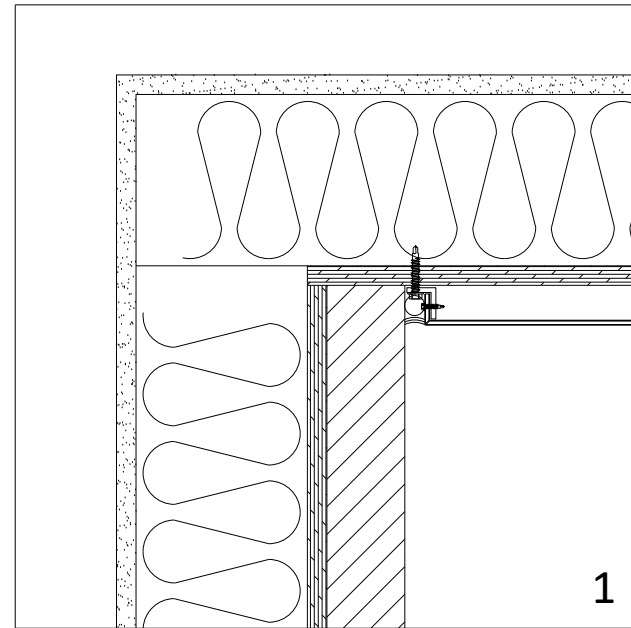

Premier Panel Systems

premierpanelsystems.com

Ph: (517) 579-3202

info@premierpanelsystems

Series PS3000

Plan Details

ACM Wet Joint System

Scale : NTS

5 April 2018

A200

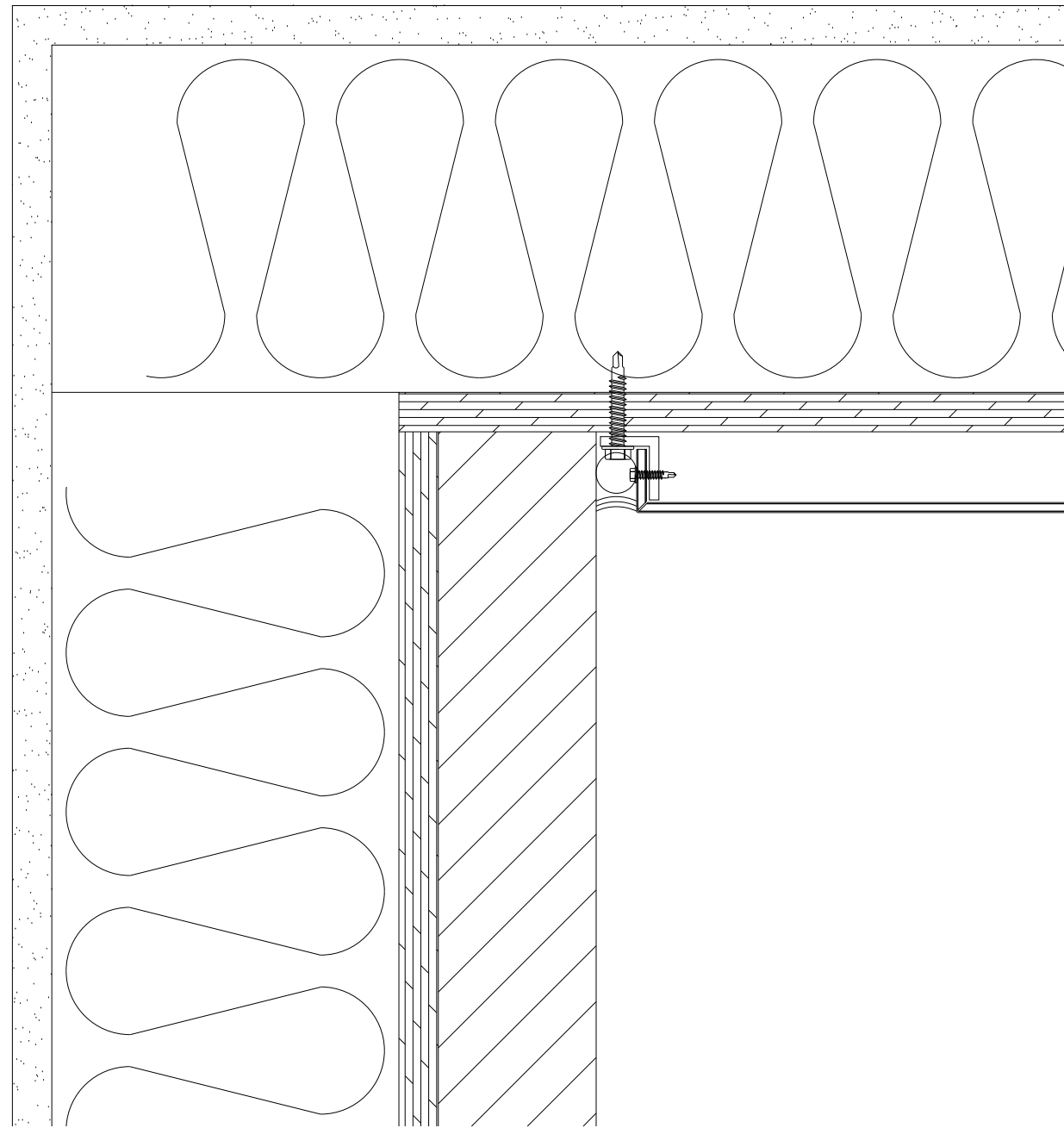

Premier Panel Systems

premierpanelsystems.com

Ph: (517) 579-3202

info@premierpanelsystems.com

Series PS3000

End Wall Detail

ACM Wet Joint System

Scale : NTS

5 April 2018

A201

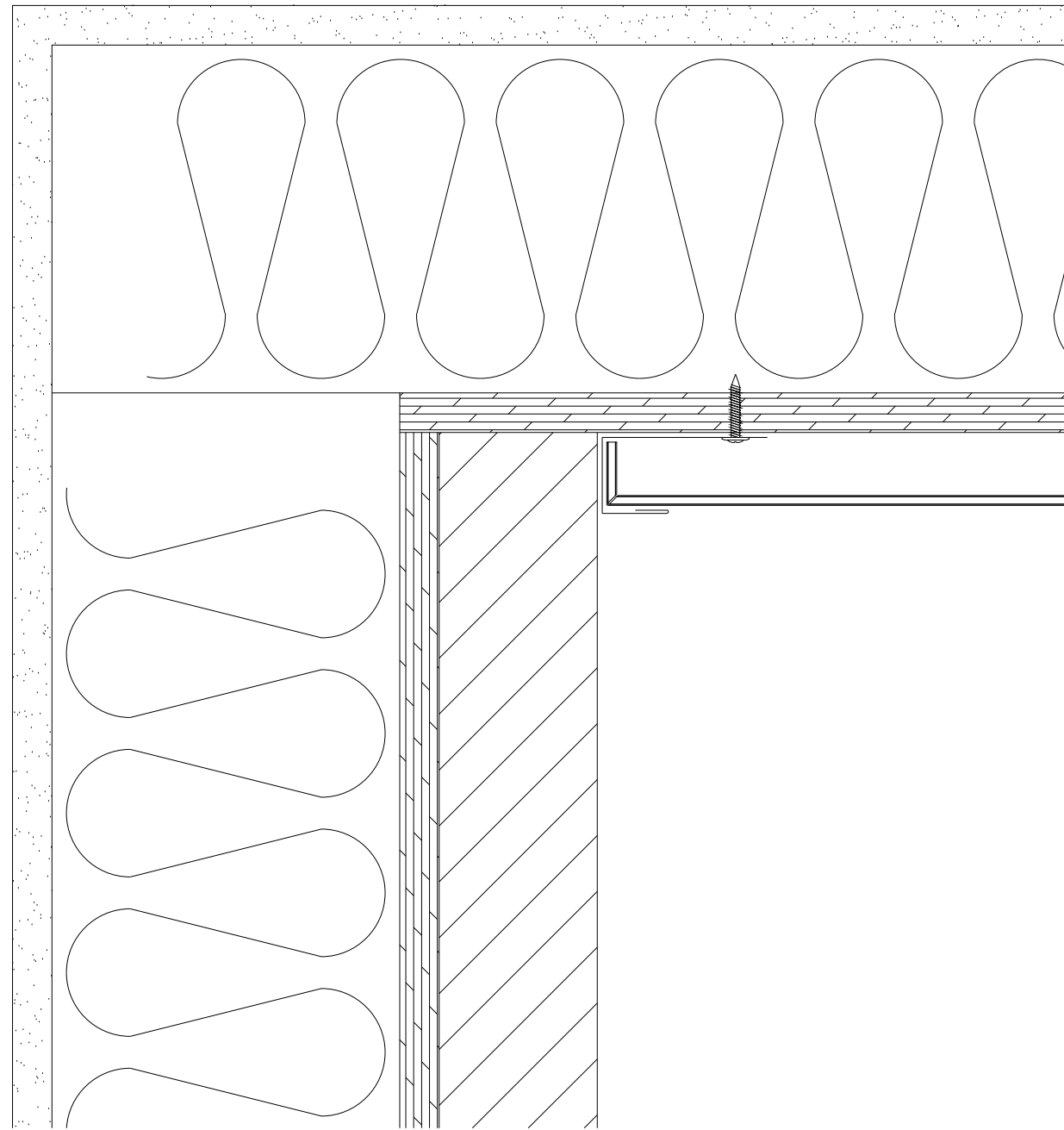

Premier Panel Systems

premierpanelsystems.com

Ph: (517) 579-3202

info@premierpanelsystems.com

Series PS3000

Optional End Wall Detail

ACM Wet Joint System

Scale : NTS

5 April 2018

A201.1

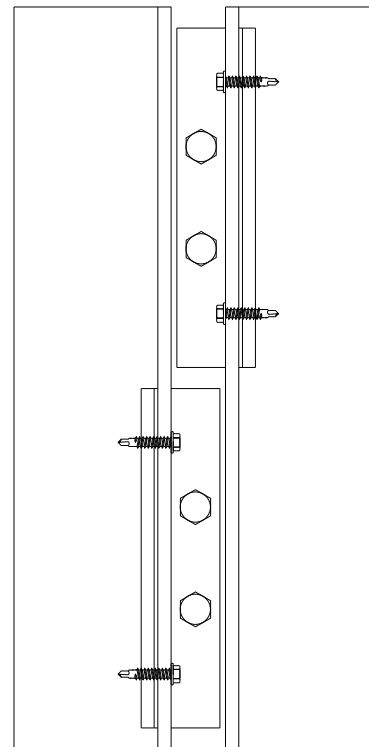
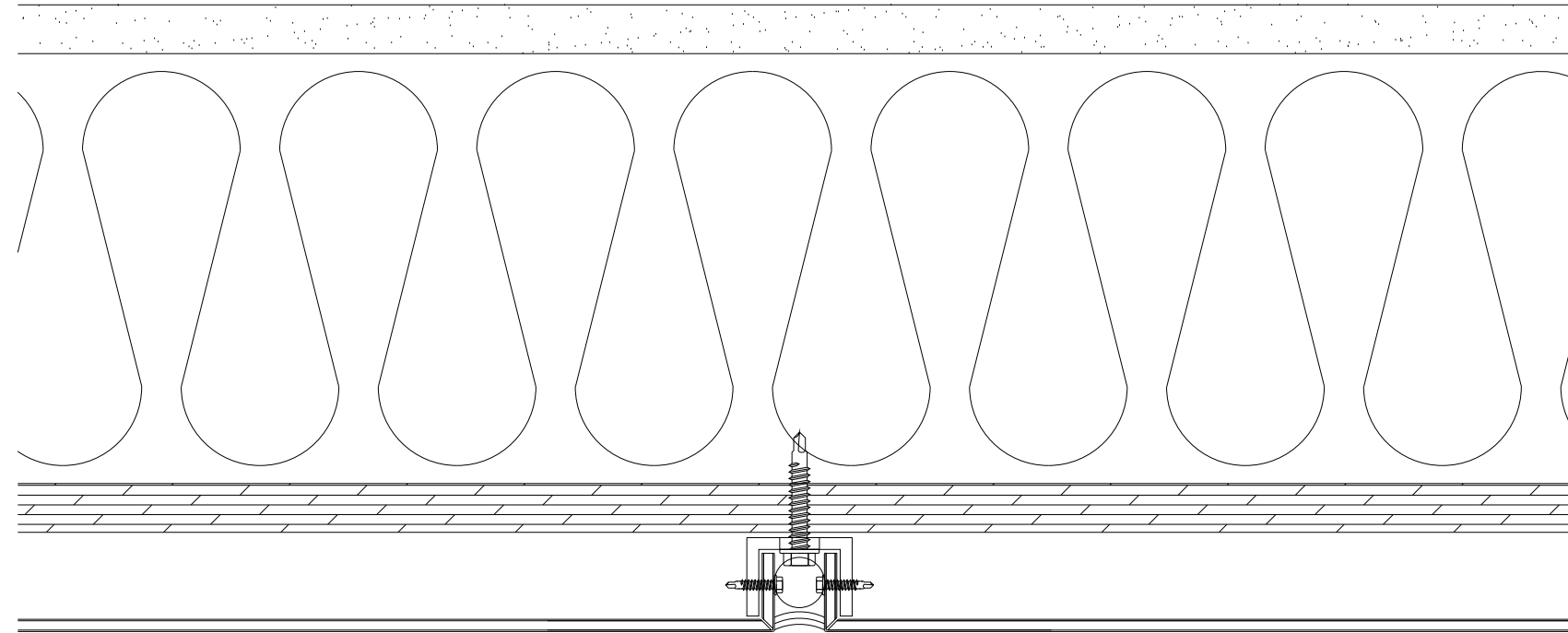

Premier Panel Systems

premierpanelsystems.com

Ph: (517) 579-3202

info@premierpanelsystems.com

Series PS3000

Vertical Panel Seam

ACM Wet Joint System

Scale : NTS

5 April 2018

A202

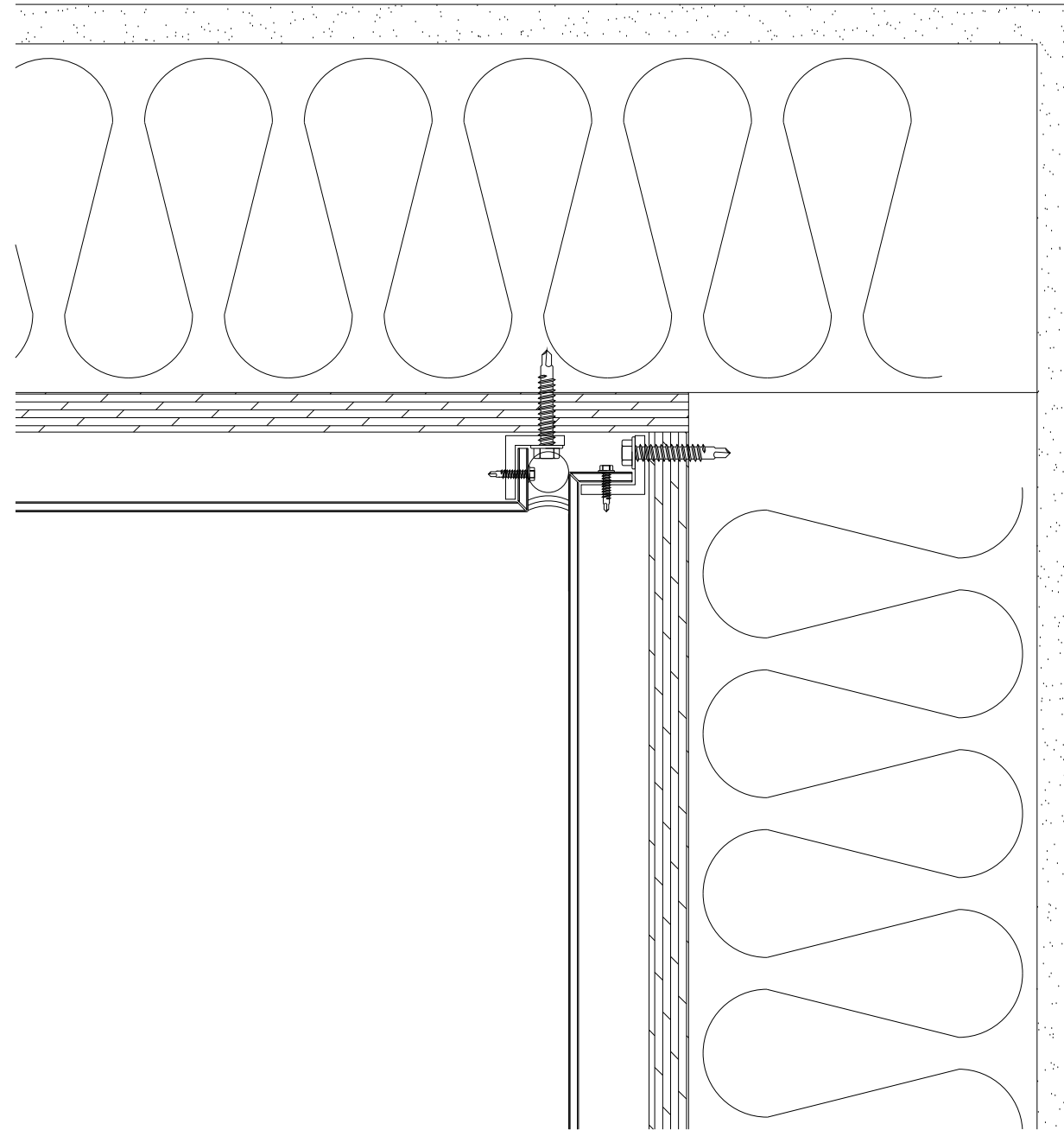

Premier Panel Systems

premierpanelsystems.com

Ph: (517) 579-3202

info@premierpanelsystems.com

Series PS3000

Inside Corner Detail

ACM Wet Joint System

Scale : NTS

5 April 2018

A203

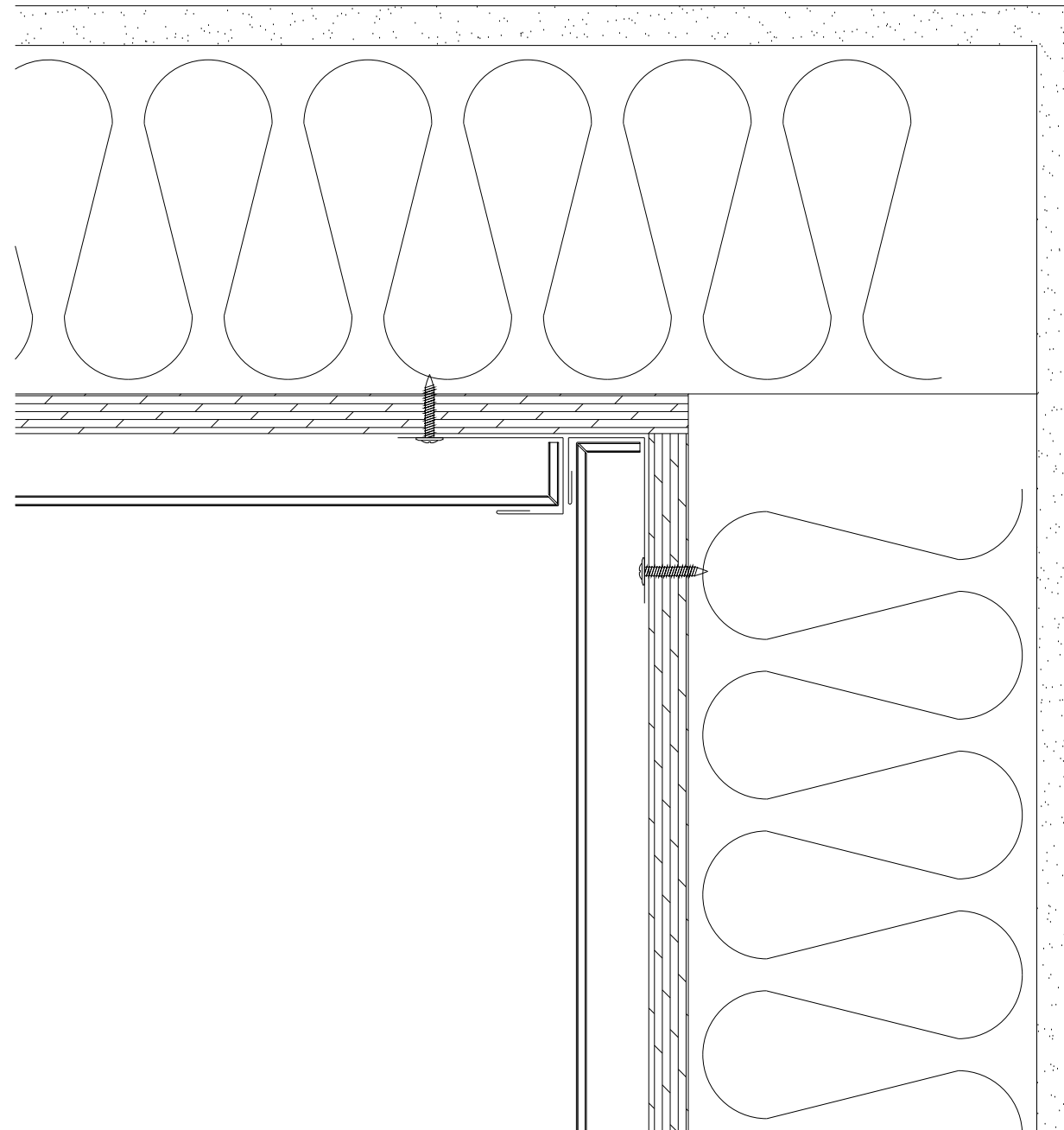

Premier Panel Systems

premierpanelsystems.com

Ph: (517) 579-3202

info@premierpanelsystems.com

Series PS3000

Optional Inside Corner Detail

ACM Wet Joint System

Scale : NTS

5 April 2018

A203.1

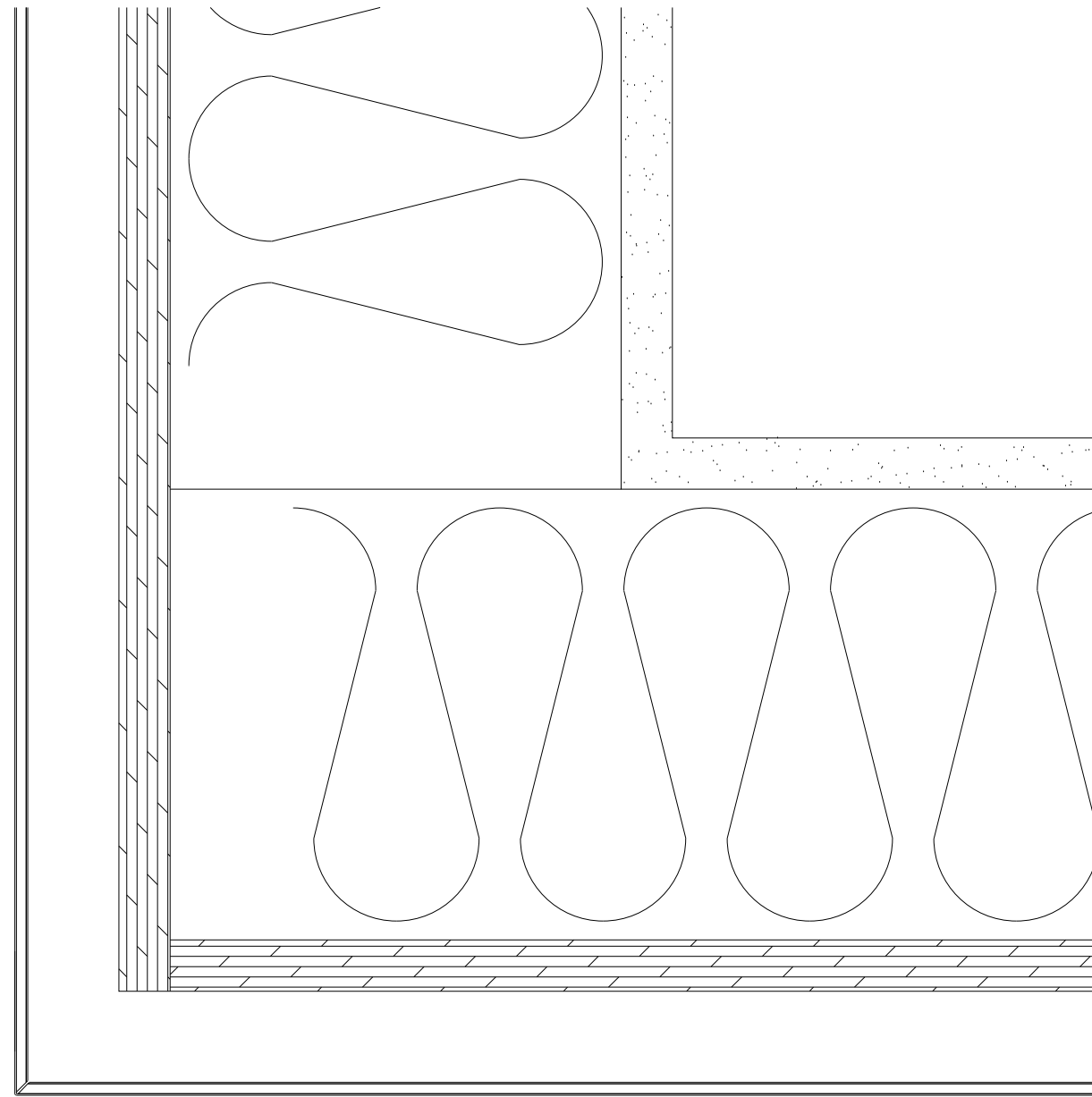

Premier Panel Systems

premierpanelsystems.com

Ph: (517) 579-3202

info@premierpanelsystems.com

Series PS3000

Outside Corner Detail

ACM Wet Joint System

Scale : NTS

5 April 2018

A204